

Standard enclosure

Series CPS

Designation CPS-280	Article number 528000000
----------------------------	---------------------------------

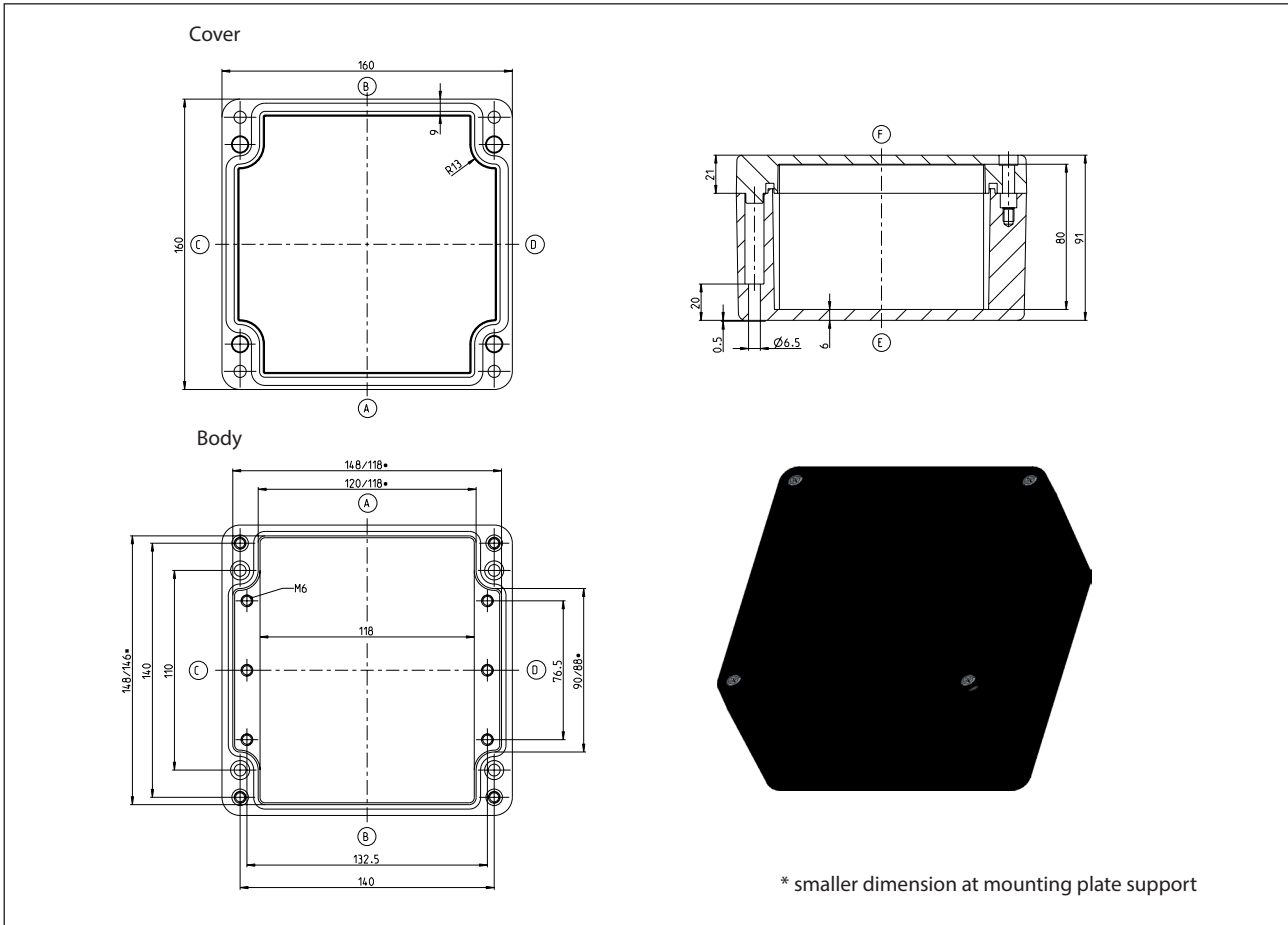

Standard version
Scope of supply:
Base of enclosure
Enclosure cover
Cover screws (cross recessed head) enclosed loosely
Colour RAL 9005 (jet black)
Cover gasket PUR (polyurethane)
Individually packaged in foil

Maximum possible number of thread (figures for identical diameter, not mixed!)								
ISO M	M12	M16	M20	M25	M32	M40	M50	M63
Page A/B	18	8	6	4	2	2	1	0
Page C/D	9	4	3	2	2	1	0	0

Property chart CPS-280

Specification	Value	According to the standard	Remark
General data:			
Weight	1130 g		
External dimensions	160 x 160 x 91		
Protection classes			
IP-code	IP 66	EN 60529	
IP-code	IP67	EN 60529	
IK- code	IK08	IEC 62262	
Material			
Enclosure	Polyester SMC 2600		jet black
Screws	A2-70	DIN EN ISO 3506-1	Cover screws
Spring washer	1.4310	DIN EN 10088-3	
Insert nuts	1.4305 CuZn39Pb3-M	DIN EN 10088-3	
Gasket	PUR (Polyurethan)		Colour: dark grey, 2-component polyurethane foam seal
Toxic behaviour	halogen-free		
Thermal properties:			
Fire behaviour			
Flammability	V-0	UL 94	Contentwise alike with EC60695-11-10 and IEC60695-11-20
Glow wire test	960 °C ; 3,2mm	IEC 60695-2-12	
Glow wire test			
Glow wire test			
Temperature range			
Enclosure without a seal	-60 °C bis +165 °C		
PUR-seal	-40 °C bis +100 °C		
Temperature index Enclosure material			
RTI (tensile strength)	130 °C	UL 746 B	
RTI (impact strength)	130 °C	UL 746 B	
RTI (dielectric strength)	105 °C	UL 746 B	
Ambient temperature according to DIN EN 62208			
Indoor application	-5 °C bis +40 °C	DIN EN 62208	On the average over 24h +35°C
Relative humidity according to DIN EN 62208			
Indoor application	max. 50% bei -40 °C	DIN EN 62208	with low temperatures also higher (for ex. 90% at +20°C)
Storage temperature	-20 °C bis +60 °C		
Enclosure-specific thermal conductivity value	2,45 K/W		taking account of effective dissipation loss

Property chart CPS-280

Specification	Value	According to the standard	Remark
Mechanical properties:			
Torques			
Cover screws	2,0 Nm		
Attachment of accessories	2,0 Nm		for ex. mounting plates, mounting rails
Other mounting	2,0 Nm		Screw channel, External mounting brackets
Maximum installation weight	1,6 kg		
Electrical characteristics:			
Rated voltage	max. 500 V		Maximum length of the extension arm
Surface resistivity	<10 ⁹ Ohm	IEC 60093	
dielectric strength	> 2 kv/cm		
More details:			
General tolerance	mH	ISO 2768	
Product standard	Yes	DIN EN 62208	Empty enclosures for low-voltage switchgear assemblies
Approvals			
c UL us	Yes	UL508A / C22,2	Type 1, 4, 4x
Compliances			
RoHs	Yes	Directive 2011/65/EU	
CE label	Yes	EC-No 765/2008	
Low-Voltage-Directive No.:	2014/35/EU		

Other versions / Accessories

The following information is not a standard. Approvals, compliances and protection classes of these versions upon request.

Other versions CPS-280	
Description of the modification compared with the standard version	Article number
RAL 9005 (jet black), with PUR seal and Socket head cap screws	upon request
RAL 9005 (jet black), with PUR seal and Socket head cap screws	5280010000

accessoires possibles/ as individual parts or as assembly set	
Description of the modification compared with the standard version	Article number
Mounting plate	9823006000
Mounting rail TS 15	-
Mounting rail TS 32	9821002000
Mounting rail TS 35	9822003000
Earthing rail (secured on central bosses C/D)	9810004000
External mounting brackets	9824004000
External articulated hinges for Enclosure CPS (mechanical machining of the enclosure required)	9801046000
Internal articulated hinges with cover guide (mechanical machining of the enclosure required)	9801032000

optional seals			
Specification	Value	According to the standard	Remark
Thermal properties:			
CR gasket	-30 °C bis +80 °C		IP66
Silicone foam seal	-60 °C bis +130 °C		IP66 / IP67
Silicone complete seal	-60 °C bis +200 °C		IP66 / IP67
EPDM seal	-35 °C bis +100 °C		IP66
HF seal	-55 °C bis +125 °C		upon request